

AI-702M/704M/706M

HIGH PERFORMANCE INTELLIGENT MULTI-CHANNEL INDICATORS

Operation Instruction Version 7.7

(Ideal for measurement, indication, alarm, calculation and retransmission of
temperature, pressure, flow, level, humidity etc.)



SUMMARY

AI-702M, AI-704M and AI-706M multi-channel indicators provide 1-2, 1-4, 1-6 channels of independent process indications, and are ideal for the measurement, indication, alarm, calculation and retransmission of temperature, pressure, flow, level and humidity etc.

Features:

- Programmable and modular inputs. Multiple input types of thermocouples and RTDs, voltage/current inputs and two-wire transmitters are field-selectable.
- Each channel can have independent input specification. All channels are equipped with digital adjustment and filtering functions and each channel has individual digital adjustment and filtering parameters.
- Customized channel number for easy reading when measuring more than 6 channels, e.g. instrument 1 shows CH1 ~ CH6 while instrument 2 shows CH7 ~ CH12.
- High performance hardware design, greatly reduces the temperature drift and the interference between channels, thus multi-channel measurement accuracy is 0.2% full scale, the same as that of single channel.
- Provide high accuracy compensation function such as ice-point compensation, copper resistance compensation and thermostat compensation to thermocouple inputs.
- Build-in accurate internal calculation functions including square root extraction, summation, subtraction and multiplication.
- Support up to 2 isolated retransmission output. Any input channel can be retransmitted to OUP port or all channels are cyclically retransmitted.
- Provide manual/auto pilot display, with 2 pilot speed selectable.
- Support up to 7 on-off signal inputs/outputs which can work as alarm output or on-off signal I/O for host computer.
- Each input channel has independent low/high limit alarm which can be assigned to any alarm output.
- Advanced communication function. Provide high accuracy and stability multi-channel analog data sampling function to host computer. The host computer can also input up to 7 channel on-off signal or execute on-off operation via the indicator.
- Up to 12 customized field parameters.
- Multiple dimensions are selectable. 100~240VAC universal power supply.
- Achieved ISO9001 and CE certificates, comply with EMC standard, high reliability and stability. The power and I/O terminals have passed the anti-interference test of 4KV/5KHz burst of pulses.

ORDERING CODE

Designed with modular principle, AI-702M/704M/706M can be equipped with 6 modules on 6 sockets: M1, M2(MIO), M3(OUTP), ALM, AUX, and COMM. M1, M2 and M3 can be equipped with various input modules, each of which has 1 or 2 analog input channels. ALM, AUX and M3(OUTP) can be equipped with relay output module, each of which has 1 or 2 alarm output channels. If necessary, M2 can also be installed with a single relay output module and work as alarm output. COMM can only be equipped with RS485 interface for communication with computer. M2 and M3 can be equipped with either analog input module for measurement or relay output modules for alarm. All inputs and outputs are programmable.

The ordering code of AI-702M/704M/706M is made up of 9 parts, for example:

AI-706M - A - J1 - J2 - J5 - L5 - L5 - S - 24VDC
 ① ② ③ ④ ⑤ ⑥ ⑦ ⑧ ⑨

Above code symbols a AI-706M instrument with: front panel dimension 96x96mm, 2 thermocouple inputs, 2 two-wire RTD inputs, 2 current inputs, 4 alarm relay outputs, RS485 communication interface and the supply power is 24VDC. The explanation for each code is below:

① Shows the model of the indicator

AI-702M, AI-704M, AI-706M respectively indicate 2, 4, 6 channels indicator.

② Shows dimension.

The depth of the instrument is about 13.5mm(foreside) + 100mm(rearward).

Model	Front Panel (width x height)	Cut-out (width x height)	Remarks
A	96x96mm	92x92mm	
B	160X80mm	152x76mm	
C	80x160mm	76x152mm	
E	48x96mm	45x92mm	
E5	96x48mm		E5 is no panel design. It is installed on DIN trail and programmed by connecting to external display or computer (S/S5 module required).
F	96x48mm	92x45mm	

③~⑧ Symbols the module type installed on sockets (M1、M2、M3、AL1、AL2、COMM):
 (“√” means the module can be installed on the according socket)

Module		M1	M2 (MIO)	M3 (OUTP)	ALM	AUX	COMM
N:	No module installed	√	√	√	√	√	√
J0:	1 channel three-wire RTD, thermocouple or mV voltage input	√	√	√			
J1:	2 channel two-wire thermocouple or mV voltage inputs	√	√	√			
J2:	2 channel two-wire RTD inputs	√	√	√			



J3:	2 channel voltage inputs of 0-1V, 0-3V, 0-5V or 1-5V etc.	√	√	√			
J4:	2 channel current inputs of 0-12mA, 4-20mA, 0-20mA etc.	√	√	√			
J5:	2 channel two-wire transmitter provided 24VDC power supply.	√	√	√			
I5:	2 channel on-off signal inputs, dry contact		√	√	√		
L1:	Single relay contact (NO+NC) output. (30VDC/2A, 264VAC/2A)			√	√	√	
L2:	Single relay contact (NO+NC) output. (30VDC/1A, 264VAC/1A)			√	√	√	
L4:	Single relay contact (NO+NC) output. (30VDC/2A, 264VAC/2A)			√	√	√	
L5:	Dual relay contact (NO) outputs. (30VDC/2A, 264VAC/2A)			√	√	√	
W1:	1 channel thyristor normal open output. ("Burnt proof" technology, able to stand 0.3A continuous current or 1A transient current)			√	√	√	
G:	1 SSR voltage output (12VDC/30mA)			√	√	√	
G5:	2 SSR voltage outputs (12VDC/30mA)			√	√	√	
S:	Photoelectric isolated RS485 interface						√
S4:	Photoelectric isolated RS485 interface with isolated power supply.						√
X3:	Photoelectric isolated linear current output			√			√
X5:	Photoelectric isolated linear current output with its own isolated power supply.			√			√
V5:	Photoelectric isolated 5VDC/50mA power supply for transmitter.				√	√	
V10:	Photoelectric isolated 10VDC/50mA power supply for transmitter.				√	√	
V12:	Photoelectric isolated 12VDC/50mA power supply for transmitter.				√	√	
V24:	Photoelectric isolated 24VDC/50mA power supply for transmitter.				√	√	

© Shows power supply: Null indicates 100~240VAC power supply, and "24VDC" indicates 20~32VDC/AC power.

TECHNICAL SPECIFICATION

- Input:

Thermocouples: (with J1 module)
K, S, R, E, J, T, B, N and WRe5-WRe26

Two-wire RTDs: (with J2 module that supports 2 inputs)
PT100, Cu50, 0~80 ohm, 0~400 ohm

Three-wire RTDs: (with J0 module that supports 1 inputs)
PT100, Cu50, 0~80 ohm, 0~400 ohm

Linear mV voltages: (with J1 module)
0~20mV, 0~60mV, 0~100mV, 0~1V

Linear voltage: (with J3 module)
0~1V, 0~3V, 0~5V, 1~5V etc.

Linear current: (with J4 module)
0~12mA, 0~20mA, 4~20mA etc.

Square root extraction calculation input: (with J3 voltage or J4 current input module)
1~5V, 4~20mA etc.

Two-wire transmitter inputs: (with J5 module that provides 24VDC power supply)
Connect to 4~20mA two wires transmitter

- Maximum lead wire resistance for RTD input:

2-wire type RTDs:
2 ohm for Pt100 or 0~400 ohm input ;1 ohm for Cu50 and 0-200 ohm input;

3-wire type RTDs:
5 ohm

- Measurement range:

K(0~1300□), S(0~1700□), R(0~1700□), T(-200~+350□), E(0~1000□),
J(0~1200□), B(0~1800□), N(0~1300□), WRe5-WRe26(0~2300□),
Pt100(-200~+800□), Cu50(-50~+150□)
Linear input: -1999~+9999 set by user

- Measurement accuracy:

±0.2%FS±1digit / ±0.3%FS±1digit (only for Cu50)

Note 1: For thermocouple inputs with internal cold junction compensation, 1□ CJC error should be taken into consideration. For those with Cu resistor, ice point or thermostat bath compensation, the accuracy is as above.

Note 2: Accuracy is not guaranteed between 0 and 600□ for type B thermocouple input.

- Temperature drift :
≤0.01%FS/□ (typical 50ppm/□)
- Electromagnetic compatibility:
IEC61000-4-4, ±4KV/5KHz; IEC61000-4-5, 4KV
- Isolation withstanding voltage:
Between power, relay contact and signal terminals ≥ 2300VDC;
Between isolated eletroweak signal terminals ≥ 600VDC
- Response time:
≤1.5 seconds (if digital filter parameter is set as 0 or 1)
- Automatic pilot time interval:
Approx. 1.2s or 2s configurable
- Alarm function:
High and low alarm, configurable separately for each channel
- Alarm output:
Relay contact output (NO or NC): 250VAC/1A or 30VDC/1A
No contact discrete output (NO or NC): 250VAC/0.3A(transient current 1A)
- Power supply:
100~240VAC/50Hz, 24VDC
- Power consumption: ≤6W
- Work ambience: Temperature -10~+60□ , Humidity ≤ 90%RH

TERMINAL LAYOUT AND WIRING

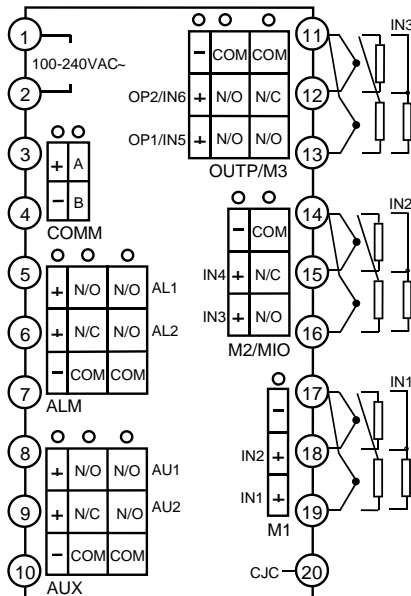

This graph is for upright instruments with dimension A, C, E.

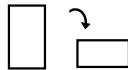

For instruments with dimension B, F, just clockwise rotate the graph for 90 degree, and the terminal numbers keep unchanged.

Thermocouple wiring:

When wiring a thermocouple input, the compensation wire should be qualified and directly connect to the corresponding terminals in correct direction. When M1 module is installed in J1 socket, a Cu50 resistor can be connected between terminal 17 and 20 to compensate the cold junction; short terminal 17 and 20 to have ice-point compensation.

Two-wire RTD wiring:

RTD can select two-wire or three-wire method by B of "AF" parameter. Two-wire method accepts input two channel signals in one module, but user has to measure and calculate the resistance of the wire. To apply two-wire method, J2 module should be installed and resistance of each wire should be less than 2ohm.

AI-702M/704M/706M can measure the lead wire resistance of two-wire method and save it to parameter "Sc". However, the lead wire resistance changes as the temperature changes. If the lead wires has the same ambient temperature as that of the instrument and no other resistor series connects to the lead wire, the indicators can compensate the resistance change by measuring the ambient temperature (compensation coefficient is 0.004/□); otherwise, two-wire method is not recommended.

Three-wire RTD wiring:

Three-wire method is a traditional wiring method requiring that the resistance of the three wires be equal. One "J0" module supports 1 three-wire RTD. Three-wire method provides higher measurement accuracy.

Maximum 3 channel of three-wire RTD is accepted. The channel number automatically shifts forward, affecting the parameter application. E.g. J0 module is installed in M1 and M2 slot for two three-wire RTD. J2 module is installed in M3. This implies the instrument accept four channels (Parameter: Cn=4, AF.B=1). There is no IN5 and IN6. Three-wired RTD is recommended to install in prior slot to avoid confusion.

Two-wire retransmission input:

AI-702M/704M/706M internally provide 24VDC power, maximum 90mA, for up to 4 two-wire transmitters. J5 module can directly be connected to two-wire transmitter. Each instrument is recommended to install not more than two J5 or V24 modules, otherwise the instrument may be failed to power on because of overload. Certain measurement error occurs due to they are commonly grounded as well. If more retransmission is

required, it should be equipped with extra 24V power supply and J4 current module.

FRONT PANEL AND OPERATIONS

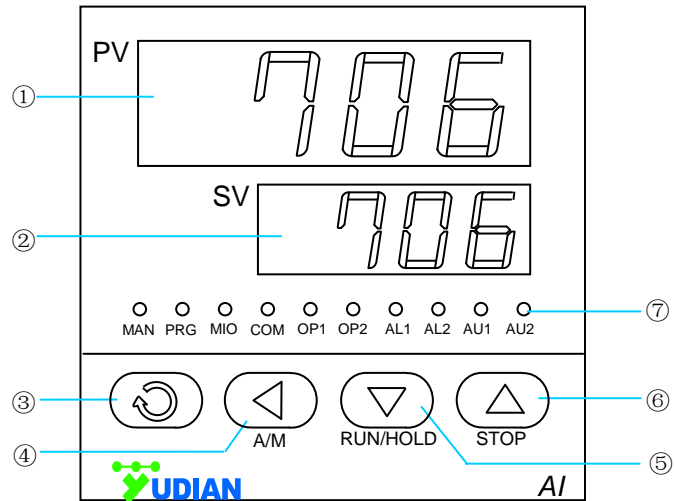

- ① Upper display window
- ② Lower display window
- ③ Set key
- ④ Data shift key (also for switching between manual/auto cyclic display)
- ⑤ Data decrease key (also for switch to display the previous channel)
- ⑥ Data increase key (also for switch to display the next channel)
- ⑦ 10 LED indication lights.













“MAN” on: Means manual circular display,
 “MAN” off: Means auto circular display.
 MIO, OP1, OP2, AL1, AL2, AU1, AU2
 indicate the input/output action of the
 corresponding module. “COM” on: communicating with the host computer.

BASIC OPERATION DESCRIPTION

1. Switch display channel:

Press  to display next channel, and press  to display previous channel. Press  can switch between auto cyclic display and manual display.

2. Parameter setting:

When the parameter lock is unlocked, press  and hold for about 2 seconds until parameter is displayed. At this moment, press  in short; all parameters will be displayed one by one. When the parameters are set and the parameter lock is locked, press  can access Field Parameter Table. The value of a parameter can be modified by ,  or . Press  to go to next parameter. Press  and hold can return to the previous parameter. Press  +  can exit parameter setting status.

3. Alarm display:

The lower display window shows channel number. If high or low alarm occurs, the first digit from the left of lower display window will show “H” or “L”, and flickers, and if over range occurs (for example, wire broken for thermocouple input), the upper display window will show high or low limit value, and the lower display window flickers.

If only 2 input channels configured, then the upper and lower display window will show the input values of channel 1 and 2 respectively. When over range occurs, the corresponding display window will flickers.

Lead wire resistance compensation for 2-wire RTD input:

Offset value (parameter “Sc”) need to be set to counteract lead wire resistance for 2-wire type RTD like Pt100 or Cu50. This offset value can be set automatically by the following procedures:

1. Short connect 2 wiring terminals on the RTD sensor side
2. Set parameter “Loc” to 808, and then press  until “A” appears on the first digit of lower display window.

3. Wait until “A” disappears, and then removes the short wire, and set “Loc” to 0 or 1.
4. Now, the instrument comes back to normal measurement display mode, and the setting of parameter “Sc” is finished.

The unit of Sc is 1/20000 of the scale of the corresponding RTD. At 0□, the total resistance of the two lead wire of Pt100 or 0~400ohm should be less than 4ohm, and that of Cu50 should be less than 2ohm. Otherwise, wire resistant compensation will not function. The smaller the resistance of the lead wire, can provide more accurate measurement.

4. DIN rail mounted type

DIN mounted type (dimension E5) has no display window. It can input analog signals or input/output on-off signals for host computer or PLC, and it can also work as a two-channel programmable re-transmitter. E5 dimension instrument has one LED indication light. When the instrument is communicating with the host computer, the light flashes with light on time different to light off time. When the instrument hasn't received signal from the host computer for 6 seconds, the indication light should flash with the same light on time and light off time.

It means:

- That the on-off period is as long as 1.6 second means no communication and no alarm (it can be treated as normal);
- The light flashing with period 0.6 second means no communication and general error occurs.
- The light quickly flashing with period 0.3 second means no communication and severe error such as input over range occurs.
- The light keeping off means the instrument power off or damaged; the light keep on (longer than 8 seconds) means the instrument power on but damaged.

The parameters of E5 dimension instrument can be set by connecting external display to the 1394 socket.

Note: The 1394 socket of the instrument only supports Yudian external display.

The instrument can connect PC or PLC to monitoring or capture the data. We can provide the FREE protocol for user or order our monitoring software-AIDCS. Please contact Yudian Sales Dept. for more detail.

5. Dry Bulb, Wet Bulb Humidity Measurement

By connecting 2 units of three-wire PT100 input, it can become the dry bulb, wet bulb humidity measurement.

1. Install J0 (RTD input module) in both M1 and M2 slot. Set Sn1=22, Sn2=42.
2. Atmospheric pressure and wind speed defined by parameter “Po” and “SPEd”
3. Initialize measurement by wrapping dry bulb with wet muslin, giving same condition with wet bulb
4. Once reading is stable, adjust parameter Sc2 to offset reading to 100%,
5. Remove wet muslin after the adjustment.
6. Recommended to set parameter (dIP1=1, dIP2=0) to have more stable reading with resolution 0.1°C and 1%RH.



PARAMETER DESCRIPTION

*x refers to channel number, can be 1~2, 1~4, 1~6 for AI-702M, 704M and 706M respectively.

Parameter	Name	Remarks	Setting range																																																												
H.ALx	High limit alarm	x channel high alarm on when PVx (the present value of x channel)>H.ALx; Alarm releases when PVx<H.AL - dFx. Set H.ALx maximum value will disable function	-1999~+9999 □ or defined unit																																																												
L.ALx	Low limit alarm	x channel low alarm on when PVx<L.ALx; Alarm releases when PVx>L.ALx + dFx. Set L.ALx minimum value will disable function																																																													
dFx	Dead band	dF is set to avoid high frequent alarm on/off actions caused by process input fluctuation.	0~999.9□ or 0~9999 units																																																												
Snx	Input specification	<table border="1"> <thead> <tr> <th>Sn</th> <th>Input spec.</th> <th>Sn</th> <th>Input spec.</th> </tr> </thead> <tbody> <tr> <td>0</td> <td>K</td> <td>1</td> <td>S</td> </tr> <tr> <td>2</td> <td>R</td> <td>3</td> <td>T</td> </tr> <tr> <td>4</td> <td>E</td> <td>5</td> <td>J</td> </tr> <tr> <td>6</td> <td>B</td> <td>7</td> <td>N</td> </tr> <tr> <td>8</td> <td>WRe3-WRe25</td> <td>9</td> <td>WRe5-WRe26</td> </tr> <tr> <td>10</td> <td>Extended input spec.</td> <td>11~18</td> <td>Spare</td> </tr> <tr> <td>19</td> <td>BA2 (JPt100)</td> <td>20</td> <td>Cu50</td> </tr> <tr> <td>21</td> <td>Pt100</td> <td>22</td> <td>Pt100 (-100.00~+300.00) □</td> </tr> <tr> <td>23~24</td> <td>Spare</td> <td>25</td> <td>0~75mV</td> </tr> <tr> <td>26</td> <td>0~80ohm</td> <td>27</td> <td>0~400ohm</td> </tr> <tr> <td>28</td> <td>0~20mV</td> <td>29</td> <td>0~100mV, 0~5V (J3); 0~20mA (J4)</td> </tr> <tr> <td>30</td> <td>0~60mV</td> <td>31</td> <td>0~1V</td> </tr> <tr> <td>32</td> <td>0.2~1V ; two-wire re-transmitter (J5)</td> <td>33</td> <td>1~5V voltage (J3) 4~20mA current (J4)</td> </tr> <tr> <td>38</td> <td>Extraction for range: 0.2~1V</td> <td>39</td> <td>Extraction for range: 1~5V (J3) 4~20mA (J4)</td> </tr> </tbody> </table>	Sn	Input spec.	Sn	Input spec.	0	K	1	S	2	R	3	T	4	E	5	J	6	B	7	N	8	WRe3-WRe25	9	WRe5-WRe26	10	Extended input spec.	11~18	Spare	19	BA2 (JPt100)	20	Cu50	21	Pt100	22	Pt100 (-100.00~+300.00) □	23~24	Spare	25	0~75mV	26	0~80ohm	27	0~400ohm	28	0~20mV	29	0~100mV, 0~5V (J3); 0~20mA (J4)	30	0~60mV	31	0~1V	32	0.2~1V ; two-wire re-transmitter (J5)	33	1~5V voltage (J3) 4~20mA current (J4)	38	Extraction for range: 0.2~1V	39	Extraction for range: 1~5V (J3) 4~20mA (J4)	0 ~ 39
		Sn	Input spec.	Sn	Input spec.																																																										
		0	K	1	S																																																										
		2	R	3	T																																																										
		4	E	5	J																																																										
		6	B	7	N																																																										
		8	WRe3-WRe25	9	WRe5-WRe26																																																										
		10	Extended input spec.	11~18	Spare																																																										
		19	BA2 (JPt100)	20	Cu50																																																										
		21	Pt100	22	Pt100 (-100.00~+300.00) □																																																										
		23~24	Spare	25	0~75mV																																																										
		26	0~80ohm	27	0~400ohm																																																										
		28	0~20mV	29	0~100mV, 0~5V (J3); 0~20mA (J4)																																																										
		30	0~60mV	31	0~1V																																																										
		32	0.2~1V ; two-wire re-transmitter (J5)	33	1~5V voltage (J3) 4~20mA current (J4)																																																										
38	Extraction for range: 0.2~1V	39	Extraction for range: 1~5V (J3) 4~20mA (J4)																																																												
<p>Note: Input spec. should be compatible with input module. For those spec. unknown, use J1 for thermocouple and mV inputs, J2 for two-wire RTD, and J0 for three-wire RTD. Multiplication: set Sn3=40, PV3=PV1 x PV2 (PV refer to input value) Summation: set Sn3, Sn4, or Sn5 =41, its input is the sum of the inputs of previous channels, e.g. when Sn5=41, PV5=PV1+PV2+PV3+PV4. Subtraction: set Sn3=42, PV3=PV2-PV1</p>																																																															



dIPx	Decimal point position	dIPx is set to select display resolution for channel x. Linear input: display resolution of dIP=0,1,2,3 are 0, 0.0, 0.00 and 0.000 Thermocouple or RTD inputs: when dIP=0, the display resolution is 1□ ; when dIP=1, the resolution is 0.1□ . Note: dIP only affects the display, and has no effect on internal data. Resolution becomes 1□ when over 1000□ .	0~3
dLx	Scale low limit	dIL and dLH define the corresponding scale range of linear inputs such as mV, 0~5V, 1~5V, 0~10mA, 4~20mA. When the temperature input is retransmitted, dIL/dIH also defined the low/high limit of temperature. For example, a pressure transmitter transfers the pressure to standard 1~5V signal and sends to input channel 1. The input of 1V indicates the pressure=0MPa, and 5V indicates the pressure=1MPa, and expected display resolution is 0.001MPa. Then the parameters should be set as below: Sn1=33, dIP1=3, dIL1=0.000, dIH1=1.000	-9990~+30000 units or 0.1□
dHx	Scale high limit		
Scx	Input offset	For thermocouple or three-wire RTD inputs, the units of Sc is 0.1□ . For example, when Sc=-100, the actual offset=-10□ , then the measured temperature will be 10□ lower than that when Sc=0. For two-wire RTD inputs, the actual offset = (Sc x signal unit). The signal unit of Pt100 or 0~400ohm input is 0.02ohm, and that of Cu50 or 0~240ohm input is 0.012ohm. For example, when Sc=-50, input type is Pt100, (-50 x 0.02ohm), then the actual offset= -1.	-1999~+4000 units or 0.1□
dLx	Digital filter	The value of dF will determine the ability of filtering noise. dL=0, no filtering; dL=1, filtering with mean; dL=2~40, filtering with mean and integral. When a large value is set, the measurement input is stabilized but the response speed is slow. Generally, it can be set to 1 to 3. If great interference exists, you can increase parameter dF gradually to make momentary fluctuation of measured value less than 2 to 5. When the instrument is being metrological verified, dF can be set to 0 or 1 to shorten the response time.	0~40



ALPx	Alarm output	<p>From right side to left side, the first, second digit of AOP respectively indicate the alarm output assignment of H.AL, L.AL, as below:</p> $\text{ALPx} = \quad \quad \quad \text{L.AL} \quad \quad \quad \text{H.AL}$ <p>Regarding to parameter value: 0 refers no output. 1,2,3,4,5,6,7 respectively sends alarm output to OP1, OP2, AL1, AL2, AU1, AU2 and MIO. Shown as below:</p> <table border="1" data-bbox="527 499 1247 800"> <thead> <tr> <th></th> <th>L.AL</th> <th>H.AL</th> </tr> </thead> <tbody> <tr> <td>No alarm</td> <td>0</td> <td>0</td> </tr> <tr> <td>OP1</td> <td>1</td> <td>1</td> </tr> <tr> <td>OP2 (L5 need)</td> <td>2</td> <td>2</td> </tr> <tr> <td>AL1</td> <td>3</td> <td>3</td> </tr> <tr> <td>AL2 (L5 need)</td> <td>4</td> <td>4</td> </tr> <tr> <td>AU1</td> <td>5</td> <td>5</td> </tr> <tr> <td>AU2 (L5 need)</td> <td>6</td> <td>6</td> </tr> <tr> <td>MIO</td> <td>7</td> <td>7</td> </tr> </tbody> </table> <p>For example: ALP1=43, low limit alarm (L.AL) of channel 1 output to AL2, ALP2=53, low limit alarm (L.AL) of channel 2 output to AU1, and both high limit alarms(H.AL) of both channel are sent to AL1.</p>		L.AL	H.AL	No alarm	0	0	OP1	1	1	OP2 (L5 need)	2	2	AL1	3	3	AL2 (L5 need)	4	4	AU1	5	5	AU2 (L5 need)	6	6	MIO	7	7	0~77
	L.AL	H.AL																												
No alarm	0	0																												
OP1	1	1																												
OP2 (L5 need)	2	2																												
AL1	3	3																												
AL2 (L5 need)	4	4																												
AU1	5	5																												
AU2 (L5 need)	6	6																												
MIO	7	7																												
Cn	Number of input channels	Define actual number of input channels. When Cn=2, the lower display the present value of channel 2 instead of the channel number.	702M: 0~ 2 704M: 0~ 4 706M: 0~ 6																											
Cno	Initial channel number	Define the initial channel number, shown on lower display, If instrument A is showing CH1~CH6, set Cno=7 in instrument B, it shows CH7~12. (704M, 706M only)																												

AF	Advanced function selection	<p>AF is used to select advanced function. The value of AF is calculated as below: $AF = Ax1 + Bx2 + Cx4 + Dx8 + Ex16$</p> <p>A=0, Slow cyclic display; A=1, Fast cyclic display. Above setting only affects display and has no effect on internal scan speed and alarm response time. B=0, RTD input use two-wire wiring; B=1, RTD input use three-wire wiring. C=0, Only channel 2 is retransmitted to COMM port; C=1, All input channels are cyclically retransmitted, and the retransmission time interval on every channel is about 3 seconds. The output ranges of all channels are defined by dIL2 and dIH2. D=0, Normal; D=1, All low limit alarms are changed to high limit alarm. E=0, Normal; E=1, Set M2(MIO) and M3(OUPT) support single channel input only.</p> <p>For example, to set a AI-702M with 2 inputs, fast cyclic display, channel 1 input from three-wire RTD (J0 module on M1 socket), channel 2 input from thermocouple (J1 module on M2 socket), current retransmission of channel 2 outputted to COMM port, the AF parameter should be set as below: A=1,B=1,C=0,D=0, then AF=19.</p>	0~31
nonc	NO/NC selection	<p>Single channel relay module provides both normal open and normal close output, while dual relay output module only provides NO output. If L5 dual relay installed, set nonc=0, all in NO status, set nonc=127, all in NC status. However, by parameter “nonc”, the NO output can be changed to NC output. $nonc = Ax1 + Bx2 + Cx4 + Dx8 + Ex16 + Fx32 + Gx64$ A,B,C,D,E,F,G respectively set NO/NC output of OP1, OP2, AL1, AL2, AU1, AU2 and MIO. 0 means the corresponding output is NO, and 1 means NC output.</p>	0 ~63, 127
OPn	Select the channel to be retransmitted	<p>OPn=0, OUPt port is for alarm output. OPn=1~4, OUPt port is used for retransmission of channel OPn. OPn=7, Re-transmit the minimum value, among all channels (defined by Cn) to OUPt OPn=8, Re-transmit the maximum value, among all channels (defined by Cn) to OUPt</p>	0~4, 7~8



OPL	Low limit of retransmission current	When OUPP works as re-transmitter, OPL/OPH define the low/high limit of re-transmission. The unit is 0.1mA. For example, to transmit the channel 1 input 0~600□ into 4~20mA output, the parameters should be set as below: dLL1=0, dIH1=600, OPn=1, OPL=40, OPH=200	0~110
OPH	High limit of retransmission current		0~220
Po	Atmospheric pressure	Defined atmospheric pressure, when dry bulb, wet bulb humidity measurement activated. Unit = KPa	1~120.0
SPEd	Wind speed	Defined wind speed, when dry bulb, wet bulb humidity measurement was activated. Unit = m/S	0.01~10.00
Addr	Communication address	Every instrument in the same communication line should be assigned to different communication address. The communication applies AIBUS protocol. Every input channel takes one address. For example, if Cn=3 and Addr=10, then the communication address 10~12 are assigned to the instrument.	0 ~100
bAud	Baud rate	When COMM module interface is used for communication, bAud defines the baud rate with range 300~19200bit/s. When linear current output module is installed in COMM socket, and bAud is set to 0~220, the COMM output can work as retransmission output. It can retransmit channel 2 input or cyclically retransmit all input channels into linear current. bAud defines the output high limit, and Addr defines the low limit. The unit is 0.1mA. For example, to output 4~20mA current, Addr should be set to 40, and bAud=200.	0 ~19.2K
Loc	Parameter lock	Loc=0: Allow to display and modify the field parameters only, which is defined in EP1~EP12. Loc=1: Display the field parameters, without modification. Loc=808: Allow to display and set all parameters.	0 ~9999
EP1-12	Field parameter	When configuration of the instrument is completed, most parameters are able to hide from field operators to avoid improper configuration. EP1~EP12 define none or up to 12 field parameters for operators from parameter table, except EP itself, like H.AL1, L.AL1 and.etc. If the number of field parameters required is less than 12(sometimes even none), define field parameters from small number, the next unused EP set to NonE. E.g. Six parameters of H.AL1 to H.AL6 (all channels' upper alarm) are need to be modified by field operators, EP setting are as follows: EP1=H.AL1, EP2=H.AL2, EP3=H.AL3, EP4=H.AL4, EP5=H.AL5, EP6=H.AL6, EP7=NonE. If no field parameter is required, just set EP1=NonE, then set Loc to 0 or 1.	NonE~bAud



Yudian (H.K.) Automation Technology Co. Ltd.
Website: <http://www.yudian.us> <http://www.yudian.com.hk>
Email: sales@yudian.com.hk Tel: +852-2770
8785 Fax: +852-2770 8796
