

AI-301 Series On-Off Signal Input / Output Module Operation Instruction

CONTENTS

1. SUMMARY.....	1
2. MODE DEFINITION	1
2.1 E5	1
2.2 D5	2
3. TECHNICAL SPECIFICATION.....	3
4. REAR TERMINAL LAYOUT AND WIRING	3
5. DISPLAYS AND OPERATIONS	4
6. COMMUNICATION INSTRUCTION	4

1. SUMMARY

AI-301M works as On-Off signal I/O interface in a computer control system. It communicates with computer through RS485 communication interface, and can provide cheap and high reliable on-off signal or frequency signal input and relay output.

AI-301M has D5 and E5 two dimensions. E5 applies the platformization concept, separates software from hardware, can be modularized assembled and can share the resource with other AI instruments. The width of D5 is only 22.5mm. D5 is not modularized and it has only two specifications: 10 channels of on-off signal inputs or 8 channels of relay outputs.

AI-301M features:

- ◆ Advanced AIBUS communication protocol, which is 2 to 10 times faster than MODBUS.
- ◆ Supports OPC communication protocol by which AI-301M can communicate with most famous Field Configuration Software.
- ◆ Up to 10 channels of I/Os. E5 is modularized and very flexible. It can support different number of I/Os
- ◆ Besides input on-off status, the on-off input function can also catch the jump from off to on, which is suitable for pushbutton switch.
- ◆ Universal 100~240VAC / 24VDC power supply.
- ◆ ISO9001 and CE certified and satisfied with EMC standard, achieving world class level of quality, anti-interference ability and safety. The power and all I/O terminals passed 4KV/5KHz EFT test, and the instrument can work stably under interference.

2. MODE DEFINITION

2.1 E5

AI-301ME5 adopts Yudian's AI-3 platform hardware, which is ideal for handling frequency and on-off signals. E5 applies advanced modularized design, and can install up to 6 modules. Users can freely choose modules to perform on-off signal input/output function. Socket COMM is specially for communication module S, and other sockets can install on-off signal input module or relay output module. M1 can install frequency input module I2, and can measure frequency signal of 0-9999Hz. The installation of module follows the principles below:

On-off signal input: Socket M1 to M5 can install I5 on-off signal input module, which can support 2 channels of inputs. The on-off signal can be relay contact signal or the collecting electrode of NPN triode with the common input terminal connecting to negative pole and signal terminal connecting to positive pole. When the circuit is open, the voltage on the triode is 20-30V. When the circuit is closed, the current pass through the triode is less than 1mA. An instrument can support up to 10 on-off signal inputs.

On-off signal output (relay contact): Relay output modules can be installed on socket M1 to M5. L1, L2, L4 are single channel relay output modules with normal open and normal closed terminals. L5 module provides 2 channel normal open relay outputs, and the 2 switches share a common terminal. An instrument can provide up to 8 channels of relay switch output, or 6 channels of relay output + 4 channels of on-off signal inputs.



E5 Serial

The ordering code of AI-301ME5 is as below:

AI-301M	E5	—	I5	I5	L5	L5	S	—	24V
1	2		3	4	5	6	7	8	9

1 indicates instrument model: AI-301M (on-off signal input/output module)

2 indicates instrument dimension: E5 is rail mounted (no LED display, its parameters can be modified by Yudian E8 display, and can be controlled by host computer)

3-8 individually indicate module type installed on M1, M2, M3, M4, M5 and COMM sockets. N means no module is installed.

(“√” means the module can be installed on the according socket)

Module	M1	M2	M3	M4	M5	COMM
N: no module installed	√	√	√	√	√	
I2: single channel on-off signal/frequency input (the external signal can be 3-12V impulse, and only M1 can measure frequency)	√	√	√	√	√	√
I5: 2 on-off signal inputs	√	√	√	√	√	
S: RS485 communication interface						√
L1: 1 relay contact (NO+NC) output. (big volume, 30VDC/2A, 250VAC/2A)	√	√	√	√	√	
L2: 1 relay contact (NO+NC) output. (small volume, 30VDC/1A, 250VAC/1A)	√	√	√	√	√	
L4: 1 relay contact (NO+ NC) output. (30VDC/2A, 250VAC/2A)	√	√	√	√	√	
L5: 2 relay contact (NO) outputs. (30VDC/2A, 250VAC/2A)	√	√	√	√	√	

Note: Limited by instrument size, the big volume relay module can not be installed on main board (M1-M3) if it is already installed in side board (M4,M5).

9 indicates power supply of the instrument. The default is 100-240VAC; 24V means 24-32VDC/AC.

The above example indicates an AI-301M on-off signal input/output module with dimension E5, I5 dual input modules are installed in M1, M2, M3 sockets, L5 dual relay output modules are installed in M4, M5 sockets (it provides 6 inputs and 4 outputs) and S module (RS485 communication interface) is installed in COMM socket.

2.2 D5

D5 dimension instruments are not modularized. The input/output interfaces are fixed on the main board. It is small, and the width is only 22.5mm. It has only two models as below:

AI-3011D5: 10 channels of on-off signal inputs and RS485 communication interface.

AI-3013D5: 8 channels of relay outputs (NAIS relay) and RS485 communication interface.



D5 series

3. TECHNICAL SPECIFICATION

- **On-off signal input** : photoelectric dry contact input, maximum withstanding voltage/current is 35V/1mA.
- **On-off signal output**: relay contact switch, 250VAC/1A or 30VDC/1A
- **Power supply** : 100~240VAC, -15%, +10% / 50-60Hz; or 24VDC.
- **Power consumption** : $\leq 2W$
- **Operating Ambient** : temperature $-10\sim 70^{\circ}C$; humidity $\leq 90\%RH$

4. REAR TERMINAL LAYOUT AND WIRING

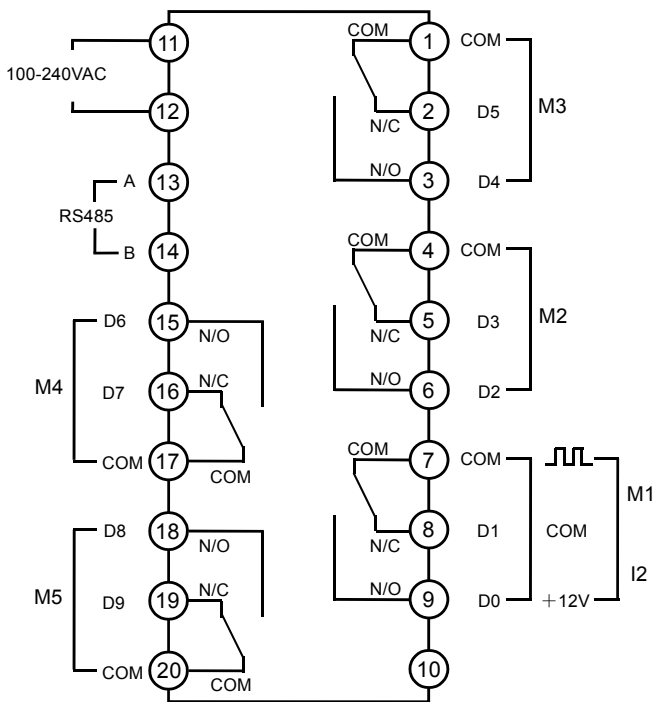

AI-301ME5

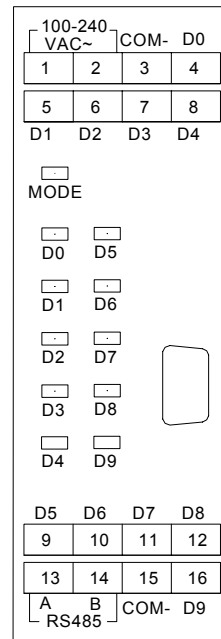

AI-3011D5

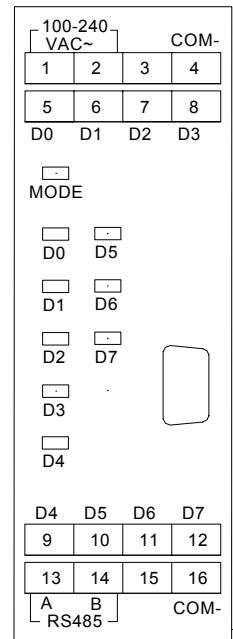

AI-3013D5

The indication lights of AI-3011D5 and AI-3013D5:

Indication lights D0~D9 show the status of the switches. Light on means "1" (switch on), and light off means "0" (switch off).

5. DISPLAYS AND OPERATIONS









AI-301 series instruments can be operated by connecting an E8 external display to the 1394 socket. The instrument parameters can be set through E8. The address range is 0 ~ 100, and the range of baud rate is 1200 ~ 19200 bit/S. The 1394 socket can only support Yudian external display.

The functions of the parts of external display panel is as below:

- ① Upper display window, display parameter code.
- ② Lower display window, displays parameter value.
- ③ Setup key.
- ④ Data shift key.
- ⑤ Data decrease key.
- ⑥ Data increase key.

Operation Instructions:

1. Set baud rate and communication address:

Pressing  and hold for about 2 seconds until parameter appears. Pressing  can go to the next parameter; pressing ,  or  can modify a parameter. Pressing and holding  can return to the preceding parameter. Pressing  (don't release) and then press  key simultaneously can save the parameter and escape from the parameter setting status.

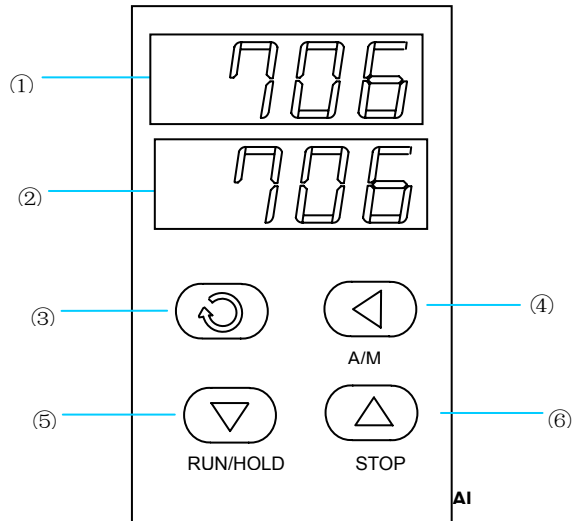

2. MODE indication light:

The AI-301 series instruments have a LED indication light MODE. When the instrument is communicating with the host computer, the light flickers with light on time different to light off time. When the instrument hasn't received signal from the host computer for 6 seconds, the indication light should flicker with the same light on time and light off time. It means:

That the on-off period is as long as 1.6 second means no communication and no alarm (it can be treated as normal);

The light flashing with period 0.6 second means no communication and some general error occurs.

The light quickly flashing with period 0.3 second means no communication and severe error such as input over range occurs.

The light keeping off means the instrument power off or damaged; the light keep on (longer than 8 seconds) means the instrument power on but damaged.

6. COMMUNICATION INSTRUCTION

AI-301 series instruments apply AIBUS communication protocol. The instruments in the same communication line should have different communication address, and LAN can be built between computers. AIBUS communication protocol v7.0 can be downloaded from www.yudian.us.

Below is some additional instruction about AIBUS communication protocol V7.0 on AI-301M series instruments.

Read on-off signals (IN):

When AIBUS read instruction reads the parameter code 10H, in the returning data, PV indicates the input frequency of M1 (D1 port), and the value of parameter code 10H indicates the status of the switches. The value of 10H is a 16 bits binary integer. From right to left, the first 10 bits (bit 0 to bit 9) indicate the status of switch D0 to D9 (0 means off and 1 means on), from the bit 10 to bit 13 indicate that the switch D0 to D3 jump from 0 to 1 (off to on) during the second read, bit 15 spare for future use, and bit 16 is always set to 0.

For example, when all the above switches are off, the value of parameter code 10H is 0 (binary: 0000000000000000). When all the switches are on, it is 1023 (Binary: 0000001111111111). When only D1 and D2 are on, and all others are off, the value should be 6 (Binary: 0000000000000110).

Write on-off signals (OUT):

When the host computer wants to control the action of relay, it sends status word to parameter code 10H.

For example, D0, D1, D2, D3, D6, D7 are relay outputs, D4, D5, D8, D9 are on-off signal inputs, normally, D5 and D8 is on, and now we want to close D0, D1, D3 and D7, then the host computer should write 139 (Binary: 0000000010001011) to parameter code 10H.

Note: Only 0 can be written to input ports. Otherwise, no matter the external switch is on or off, the read bit is 1.